



Model 5500 Pilot Operated Pressure Relief Vent w/ Pipeaway Connection

SECTION I

I. DESCRIPTION AND SCOPE

The maintenance of this Pilot Operated Vent Valve (POVV) should only be done by qualified valve technicians. It is important that the technician be familiar with the API and corporate standards, corporate safety policies and the relief vent manufacturer requirements. When repair services are performed by an outside company, the company needs to be a Cashco factory authorized repair center which specializes in low pressure venting devices.

For information on repair centers in your area, please contact:

Valve Concepts, Inc.
%Cashco, Inc.
607 West 15th Street
Ellsworth, KS 67439-0006
(785) 472-4461 (Phone)
(785) 472-3539 (Fax)

SECTION II

II. VALVE DESIGN AND FUNCTION

The Model 5500 Pilot Operated Vents are used on liquid storage tanks and other process vessels or systems to prevent structural damage due to excess internal pressure. This excess pressure is vented out through a pipeaway connection.

Storage tanks are pressurized when liquid is pumped in, compressing the existing vapor or when increasing temperature causes increased evaporation or expansion of existing vapor. Conversely, a vacuum may be created when fluid is pumped out or as atmospheric temperature decreases. To prevent structural damage, vapor must be allowed to escape or enter the tank at a specified flow rate. The volume rate of venting is dependent on the tank size, displacement rate and the flash point of the fluid. See API Standard 2000 for procedures to determine venting requirements.

A pilot operated relief vent has two principal advantages over other relief vent designs:

1. Bubble tight shutoff up to 100% of set point.
2. Full open capacity for pressure relief is achieved within 10% above set point.

Thus the vent valve is capable of operating at pressures closer to the maximum allowable working pressure of the tank. Operating at higher pressures reduces evaporation and total venting volume, thereby reducing product loss and the cost of handling emissions.

Each application must be reviewed to ensure material compatibility with all metal and soft good components with the service conditions. The pallet assembly, wetted components and tubing are 316 SST. Diaphragm material is FKM, unless specified otherwise.

The pilot valve is factory set to comply with the specifications on the purchase order. The adjustable pressure range is a function of the installed spring and will be stamped on the metal nameplate. The set point pressure maybe changed within the design parameters of the spring while installed on line or in a maintenance shop. See Section IX for setting and testing procedures.

This manual is intended to provide recommended procedures and practices for installation, operation and maintenance of the Model 5500 POVV. Although this manual cannot cover all possible contingencies, these guidelines will provide safe and reliable pilot valve performance.

SECTION III

III. SAFETY WARNINGS



WARNING

Warning: Before beginning any relief vent inspection or maintenance, carefully read and understand the information in this manual. If there are any questions concerning the information in this manual, please contact the factory or an authorized repair center before proceeding.

Tank or system protection is the primary function of the Pilot Operated Vent Valve (POVV). It must be selected to meet the total pressure flow requirements within the maximum allowable working pressure of the system on which it is installed. Consult API Standard 2000 for tank protection sizing procedures. Improperly specified relief vents may result in structural damage to the tank or system, and can cause severe personal injury or death.

In the event of a diaphragm failure, the Model 5500 will vent pressure to the pipeaway connection causing the pressure relief valve to fail in the OPEN position. The vent will now function like a weight loaded vent under this condition with a lower set point. Consult the factory for any questions related to this over-pressure condition.



CAUTION

DO NOT attempt to change pressure set point beyond the limit specified on the nameplate..

The 1/2" OD SST pilot valve sensing line must be kept open and unobstructed to ensure that the pilot "senses" the actual tank pressure. For applications where tank vapors may condense or polymerize in the sensing tubing or the pilot valve, a nitrogen purge may be required to prevent internal obstruction of the tube. Consult the factory for recommendations.



CAUTION

DO NOT attempt to remove the vent from the tank or process vessel without first bleeding all pressure from the system. ALTERNATIVE MEANS OF PRESSURE RELIEF MUST BE PROVIDED WHEN THE VENT IS OUT OF SERVICE.

After isolating the relief vent, bleed all pressure from both main and pilot valve before removing the Model 5500 POVV.

NOTE: Both the pilot valve and main valve are exposed to the process vapors. Observe all plant procedures and Material Safety Data Sheet recommendations before inspecting, adjusting or servicing any components.

The vent on the spring bonnet of the pilot must be clean and unobstructed for proper and safe operation of the valve.

SECTION IV

IV. SHIPPING, INSPECTION AND STORAGE

The pressure relief vent is carefully packaged to prevent damage or contamination during shipping. Inspect the equipment when it is received and report any damage to the carrier immediately. The POVV should be stored in a clean environment with all the protective flange covers in place to prevent intrusion of foreign materials. If there are indications of physical damage or internal contamination, the valve may need to be disassembled, cleaned and inspected prior to installation.

Lifting brackets may be provided on the main valve for lifting and handling. To avoid damage to the lower flange surface, rest the vent on a soft clean gasket material until it is ready to be installed. **DO NOT** store the POVV directly on the ground.

SECTION V

V. INSTALLATION

The Model 5500 POVV is a precision device that must be handled carefully to ensure seat tightness.

WARNING

The vent must be installed in a vertical position. The tank nozzle on which the vent is mounted should have the same nominal diameter as the venting device. It is recommended that the tank nozzle flange face be within 1 degree of horizontal for best performance of the venting device.

1. At installation, the POVV should be carefully lifted into position using the lifting brackets on the body. Use the case assembly (114,116) to help align the body directly over the tank nozzle. **DO NOT** use the pilot valve or pickup line to pull the POVV into position.
2. Aluminum body vents should be mated to flat-faced 125# ASME flanges. Mating flanges should be flat within 0.020" and clean; free of scratches, corrosion and tool marks. A full faced gasket is recommended.
3. Install the flange gasket on the nozzle face. Use either a full faced or ring gasket for raised face flanges. Ensure that the gasket material is suitable for the service. See Table 1 for gasket dimensions.

Table 1 Body Flange Gasket Dimensions					
CS, SST 150# ASME RF	O.D.	I.D.	B.C.	Hole	Qty
2"	4.12	2.38	--	--	--
3"	5.38	3.50	--	--	--
4"	6.88	4.50	--	--	--
6"	8.75	6.62	--	--	--
8"	11.00	8.62	--	--	--
10"	13.38	10.80	--	--	--
12"	16.12	12.80	--	--	--
Alum w/ 125# ASME FF					
2"	6.00	2.00	4.75	.75	4
3"	7.50	3.00	6.00	.75	4
4"	9.00	4.00	7.50	.75	8
6"	11.00	6.00	9.50	.88	8
8"	13.50	8.00	11.75	.88	8
10"	16.00	10.0	14.25	1.00	12
12"	19.00	12.00	17.00	1.00	12

4. Center the gasket within the bolt circle of the tank nozzle flange.

NOTE: At installation, the vent valve should be carefully lifted into position using the lifting brackets on the body.

CAUTION

The lifting brackets should only be used for lifting the vent valve into place and should NOT be used for any other purpose.

5. Lubricate all studs and nuts with an appropriate thread lubricant. If stainless steel studs and nuts are required, use an anti-seize lubricant such as moly-disulfide.
6. Remove flange protective cover and carefully set the POVV down on the gasket and face of the nozzle flange.

WARNING

Minimum clearance between tank roof and vacuum inlet port must be at least equal to the vents' nominal flange bore. Tank nozzle bore must be greater than or equal to vent inlet flange bore. Inlet piping loads must be supported by appropriate structural supports, NOT by the vent body.

7. Install lockwashers and nuts. Tighten nuts to half the recommended torque value using an alternating crossing pattern. See Table 2.

Table 2 Recommended Minimum Torque Values *				
Size	Qty Holes	Bolt (UNC)	Torque (lb-ft)	
			Raised Face	Flat Face
2"	4	5/8"-11	31	81
3"	4	5/8"-11	43	106
4"	8	5/8"-11	29	68
6"	8	3/4"10	51	101
8"	8	3/4"-10	78	142
10"	12	7/8"-9	75	138
12"	12	7/8"-9	93	179

* Torque values are based on a gasket factor $m = 3.5$, gasket factor $y = 4000$ psi, operating pressure = 30 psi

8. Make sure that the gasket is compressed evenly and the flanges are not distorted.

NOTE: Misalignment of flange faces will cause bending stresses at the flange and may damage flange joint. Refer to Addendum-A on pages 16 and 17.

9. Finish tightening nuts to the point that no additional rotation occurs.

SECTION VI

VI. PILOT MAINTENANCE

A. General:

1. Maintenance procedures herein after are based upon removal of the pilot/vent valve unit from the vessel/piping where installed.
2. Owner should refer to owner's procedures for removal, handling and cleaning of nonreusable parts; i.e. gaskets, suitable solvents, etc.
3. All indicated Item Numbers that are with respect to the Pilot Assembly will be in parenthesis and underscored; i.e. (29). All Item Numbers that are with respect to the Main Valve are not underscored; i.e. (108).

B. Separation from Main Valve and Disassembly:

1. Disconnect sense tube (124) from fittings (123) and (122). Also, disconnect the discharge tube (125) from tube connectors (122). Remove the pilot valve assembly from the nipple (121) by rotating the pilot body (01) CCW.
2. Secure pilot body (01) in vise with 'sensing' port facing front. Disconnect tubing (34) from connectors (32), (33).
3. Paint or embed a set of match marks between upper case (22), spacer (13) and lower case (03) along flanged area. *Note the location of 1/8" NPT tap from elbow (33) in relation to body sensing port and straight connector (32).*

4. Rotate the closing cap (29) CCW for removal. Loosen the adjusting screw nut (27) two revolutions. Rotate Adjusting screw (28) CCW and remove.
5. Remove diaphragm case nuts (19), flat washers (25) and cap screws (26). Grasp spring bonnet (23) and lift up until diaphragm case (22) clears top of spring button (21). Set assembly aside.
6. Lift range spring (20) and spring button (21) up and set aside.
7. Insert a tool in slot in the top of stud (18) to prevent stud rotation. Rotate nut (19) CCW to remove nut and spring guides (17).
8. Remove sense pressure ring (15), sense support plate (16), sense diaphragm (14) and diaphragm case spacer (13).
9. Remove top bolt gasket (07), and sense diaphragm spacer (12).
10. Remove support plate-boost (11), boost diaphragm (10), boost diaphragm spacer (09) and another bolt gasket (07).

FOR Pilot with Pressure \geq 3.2 psig: remove boost pressure ring (36).

11. Rotate 7/16" hex head cap screws (04) CCW to remove. Lift up on lower diaphragm case (03) to remove lower case and gasket (02). **NOTE** the alignment of the four bolt holes and the sense hole in case (03) with the holes in the body (01).
12. Grasp spindle stud (18) and lift upwards to extract the spindle assembly (06) from the



WARNING

SPRING UNDER COMPRESSION. Prior to removing flange bolts, relieve spring compression by backing out the adjusting screw. Failure to do so may result in flying parts that could cause personal injury.

body (01). Remove seal diaphragm (08) from spindle. With a pick type tool lift out seat o-ring (05).

13. Rotate jam nut (27) CCW two rotations and remove blowdown needle (28) from body (01). Replace with new O-ring (30).
14. Inspect parts and replace if parts show signs of wear. Clean parts with suitable cleaner.

C. Re-assembly:

1. Insert new seat o-ring (05) in the bottom of the spindle assembly. Place spindle assembly inside the body cavity, threaded end up. Slide a new seal diaphragm over threaded end of spindle and position it on top of the body. Align holes in seal diaphragm with holes in body.
2. Position new body gasket (02) on top of the seal diaphragm, align gasket holes. **DO NOT cover sensing hole in the body.**
3. Align holes in the lower diaphragm case (03) with body (01) and place the case on top of the gasket. **DO NOT cover sensing hole.** Use cap screws (04) to secure lower diaphragm case (03) to the body. (01). Tighten to 10-15 ft. lbs.
4. Slide one bolt gasket (07) and boost diaphragm spacer (09) over threaded end of spindle (18).
5. Place another bolt gasket (07), the boost diaphragm (10), and the support plate-boost (11) on spindle stud (18). Align bolt holes for all parts.
FOR Pilot with Pressure \geq 3.2 psig: install boost pressure ring (36).
6. Install sense diaphragm spacer (12) and the last bolt gasket (07) on spindle stud (18).
7. Place the diaphragm case spacer (13) on top of the diaphragm (10), (or on top of the boost pressure ring (36)) and align match marks per previous B 3.

8. Install a new sense diaphragm (14) on spindle stud (18) and align the bolt holes with the boost diaphragm (10) and spacer (13).
9. Stack the sense support plate (16) and the spring guides (17) over end of spindle stud (18)
10. Install and tighten nut (19) to secure all parts. (Check alignment of the bolt holes around the circumference.)
11. Position the range spring (20) and spring button (21) on the spring guides (17).
12. Place pressure ring (15) on top of diaphragm (14). Recheck alignment of bolt holes.
13. Lower the upper diaphragm case (22) / spring bonnet (23) assembly over the spring (20), allow to rest on the pressure ring (15). (Ensure alignment of match marks per previous B 3.)
14. Install diaphragm case screws (26), flat washers (25), and nuts (19) and tighten.
15. Apply a light coat of Bostik Never-Seez to threads of blowdown needle (28). Thread completely into body until the nut (27) contacts the body (01) and then back out two rotations. Rotate nut (27) CW to secure nut tight.
16. Reinstall adjusting screw (28) and jam nut (27) in top of spring bonnet (23). Install closing cap (29).
17. Refer to Section IX for Calibration and Testing.
18. Install pilot body assembly on nipple (121) tight with CW rotation. Ensure the sense tube connector (122) of the pilot valve assembly is directly above sensing tube connector (123) of the main valve assembly.
19. Reconnect tubing (34) to fittings (32), (33) and tubing (124) to fittings (123),(122). Then, reconnect discharge tube (125) to fitting (122).

SECTION VII

VII. VENT VALVE MAINTENANCE



CAUTION

If the vent valve must be removed from the tank for any reason, make sure that all pressure has been released before the flange fasteners are loosened. Refer to your company procedures before venting the tank pressure and when handling toxic or otherwise hazardous materials. Observe all standard safety precautions as specified on Material Safety Data Sheets for the product(s) in the system while removing the valve and during the repair.

A. General:

1. The Model 5500 POVV does not require routine lubrication or adjustments. It should be checked periodically, at least twice a year, to confirm that the vent is functioning properly and that the set point is correct.
2. The pilot valve is designed to function in a fail-safe manner. The failure of a seal or a diaphragm will cause pressure to be vented out through a pipeaway connection; the resulting loss in pressure will cause the main valve to open under rising pressure.
3. Periodic inspection for seat tightness should be done to ensure compliance with local air pollution control requirements. If the pipeaway connection relieves to the atmosphere, this maybe accomplished with a gas detector calibrated for the principle product in the system.
4. The vent valve will need to be removed from the tank for inspection of diaphragms, gaskets and seals. When this is done, the vent must be handled carefully using the lifting brackets (119) and the body.
5. The main and pilot valve housings, bodies, pallet assembly and other components are exposed to the process vapor.

B. Disassembly:

1. Disconnect the tubing connections (pilot to main Valve) (123, 124, 125 and 122) and remove the pilot by rotating the pilot body (01) assembly CCW from nipple (121).

Actuator Diaphragm Replacement:

- a. Paint or embed a set of match marks between upper case (116) and lower case (114) along flanged area.
- b. Loosen and remove nuts (118) and cap screw (117).
- c. Lift up and remove the upper case (116) assembly and set aside. Remove joint tape (130) and diaphragm (128). **NOTE: To continue with disassembly - skip to Pressure Pallet Diaphragm Replacement below.**
- d. Replace with new parts (130 and 128). Position and align bolt holes in the circumference of the diaphragm with the holes in the lower case (114).
- e. Reposition upper case assy (116) on diaphragm (128). Align marks made in step (a.) above.
- f. Install cap screws (117) and nuts (118) and tighten.
- g. Install pilot body assembly on nipple (01) tight with CW rotation. Ensure straight connector (122) of the pilot valve assembly is directly above sensing tube connector (123) of the main valve assembly.
- h. Reconnect tubing (124) to fittings (123),(122). Then, reconnect the discharge tubing (134) to fitting (31) and sense tube connector (132) Refer to Section IX for Calibration and Testing.

Pallet Diaphragm Replacement:

(Disassembly continues from c. above)

- a. Paint or embed a set of match marks between cover (111) and pipeaway body (101).
- b. Rotate cover nuts (112) CCW and remove. Grasp the lower and upper case assembly (114,116) and lift straight up to remove cover (111).

NOTE: Support plate (127) will also lift out of pipeaway body (101). Pressure pallet stem(106) assembly will remain on seat ring (102).

c. Lay the whole upper case assembly aside on a flat surface.

d. Lift pressure pallet stem assembly (104) out of the pipeaway body (101). Carefully secure stem (104) in a vise, oriented such that the pallet (106) assembly is directed upwards.

e. Remove lock nut (109), diaphragm retainer plate (108), diaphragm (107), pallet (106) and stiffner plate (105) from stem (104).

f. Inspect and clean seat ring (102). Check seat surface for any nicks, corrosion, pitting or product build up. Seat surface must be clean and smooth for vent to perform properly. (**Continue with step j. unless changing gasket (49).**)

To Remove Adapter Gasket: steps (g - i).

g. Paint or embed a set of match marks between cover (111) and lower case adapter assy (114).

h. Loosen and remove adapter bolts (115). Lift cover (111) up and over support plate (127). Remove and replace adapter gasket (113).

i. Re-install cover (111) and align match mark from g. above. Install adapter bolts (115). Tighten securely.

j. Re-install stiffner plate (105) and pallet (106) on stem (104). **NOTE:** Apply small amount of TFE lubricant around the center opening (top surface) of the pallet (106).

k. Place a new diaphragm (107) on the pallet (106). **NOTE:** Apply small amount of TFE lubricant around the center opening (top surface) of the diaphragm (107).

l. Install the diaphragm retainer plate (108) and nut (109).

m. Remove stem (104) assembly from vise.

To Remove Pressure Pallet Seat Ring:

NOTE: For replacement of integral or pressed in seat rings, please contact factory.

Paint or embed a set of match marks between the seat ring (101) and the inside of the body.

n. Rotate bolts (103) CCW and remove. Place a wrench on the milled flats of the pallet guides (110), rotate CCW to remove. Mark location of guides on the edge of seat ring (102) for reference at re-assembly.



CAUTION

The pipeaway body (101) is no longer fastened securely to the body (100) and could fall and cause severe personal injury and material damage.

o. Lift up to remove seat ring (102) and joint tape (130). (There is no tape on integral or pressed in seat rings.) Inspect guides (110) and inside of the body cavity for any corrosion or product build-up. Clean all parts as necessary. Seat surfaces must be clean and smooth for diaphragm and pallet to seal properly.

p. Install new joint tape (130). Align match marks for seat ring (101) with body, place seat ring back in body, resting on joint tape. Re-install pallet guides (112) around the seat ring as previously marked. Install bolts (103). Tighten bolts (102) and guides to 15 ft. lbs. (20.3 Nm).

q. Place stem/pallet (104/106) assembly back on seat ring (102).

r. Place a piece of joint tape (130) on face of pipeaway body. Position pressure cover (111) on pipeaway body. Align match marks for cover and pipeaway body. Install cap screws (112) to secure cover to pipeaway body.

s. Insert small end of support plate (127) down through the hole in the center of the lower case (114) until it slides over the top of the pressure stem (104).

t. Install new piece of joint tape and diaphragm (130 and 128). Position and align bolt holes in the circumference of the diaphragm with the holes in the lower case (114).

u. Reposition upper case assy (116) on diaphragm (128). Align match marks made in step B. 1. a. previous. Install cap screws (117) and nuts (118) and tighten.

v. Install pilot body assembly on nipple (121) tight with CW rotation. Ensure straight connector (122) of the pilot valve assembly is directly above sensing tube connector (123) of the main valve assembly.

w. Reconnect tubing (34) to fittings (32), (33) and tubing (124) to fittings (123), (122), and tubing 125 to fittings (122).

SECTION VIII

VIII. ORDERING INFORMATION

NEW REPLACEMENT UNIT vs PARTS "KIT" FOR FIELD REPAIR

To obtain a quotation or place an order, please retrieve the Serial Number and Product Code that was stamped on the metal name plate and attached to the unit. This information can also be found on the Bill of Material ("BOM"), a parts list that was provided when unit was originally shipped. (Serial Number typically 6 digits).

NEW REPLACEMENT UNIT:

Contact your local Cashco, Inc., Sales Representative with the Serial Number and Product code. With this information they can provide a quotation for a new unit including a complete description, price and availability.

PARTS "KIT" for FIELD REPAIR:

Contact your local Cashco, Inc., Sales Representative with the Serial Number and Product code. Identify the parts and the quantity required to repair the unit from the "BOM" sheet that was provided when unit was originally shipped.



CAUTION

Do not attempt to alter the original construction of any unit without assistance and approval from the factory. All purposed changes will require a new name plate with appropriate ratings and new product code to accommodate the recommended part(s) changes.

NOTE: *Those part numbers that have a quantity indicated under "Spare Parts" in column "A" reflect minimum parts required for inspection and rebuild, - "Soft Goods Kit". Those in column "B" include minimum trim replacement parts needed plus those "Soft Goods" parts from column "A".*

If the "BOM" is not available, refer to the cross-sectional drawings included in this manual for part identification and selection.

A Local Sales Representative will provide quotation for appropriate Kit Number, Price and Availability.

The contents of this publication are presented for informational purposes only, and while every effort has been made to ensure their accuracy, they are not to be construed as warranties or guarantees, express or implied, regarding the products or services described herein or their use or applicability. We reserve the right to modify or improve the designs or specifications of such product at any time without notice. Cashco, Inc. does not assume responsibility for the selection, use or maintenance of any product. Responsibility for proper selection, use and maintenance of any Cashco, Inc. product remains solely with the purchaser.

SECTION IX

IX. PRESSURE CALIBRATION AND TESTING PROCEDURE FOR PILOT

1. To determine set pressure, slowly increase the pilot inlet pressure. Simulated actuator pressure will rise with inlet. As set pressure is approached, the actuator pressure will begin to decrease. Continue to increase the inlet pressure slowly until the actuator pressure is 90% (+/- 10%) of the inlet pressure. This is the set pressure.
2. Rotate the set pressure adjusting screw (28) CW to increase set pressure or CCW to decrease set pressure. Continue to rotate the adjusting screw and repeat the test per Step 1 previous until the specified set pressure is achieved.
3. To determine reseal pressure, slowly decrease the inlet pressure and the actuator pressure will begin to increase. Reseat occurs when the actuator pressure equal the inlet pressure.
4. The difference between set and reseal pressure, "blowdown", can be adjusted with the blowdown needle (28). Maximum clockwise rotation provides rapid relief valve opening, "snap action" and maximum blowdown. Standard blowdown, unless otherwise specified is 7 - 10% below set pressure.
5. Increased counter clockwise rotation of blowdown screw provides "modulating" action and minimum (zero) blowdown. Reseat pressure is the same as set pressure.

NOTE: The blowdown needle is located in a pressure containing chamber, and is retained by the blowdown o-ring (30) and blowdown locknut (27). DO NOT remove the blowdown needle while under pressure.

6. Remove body vent and install a flexible tube in this port. Immerse this pilot discharge bubble tube in water approximately 1/4" below surface to detect cracking and reseal pressure.

7. A small interaction occurs between set pressure and blowdown adjustments. Re-adjustment of both may be required until the specified set pressure and blowdown are achieved. After completion, lock both screws and locknuts and replace closing cap (29) on adjusting screw (28).
8. Hold the valve at the set pressure while performing a soap bubble test of all bolted, flanged and threaded connections.
9. Refer to Table 3 for standard setting Specifications.

TABLE 3 SETTING SPECIFICATIONS - PILOT VALVE				
Pilot Action	Set Pressure	Set Pressure Limits	Maximum Cracking Pressure % of Set	Reseat Pressure % of Set
Snap	2" - 8" WC	+/- 0.2"WC	75	90 +/- 3
Snap	8.1" WC - 1.0 psig	+/- 3%	90	90 +/- 3
Snap	1.1 - 15.0 psig	+/- 3%	95	93 +/- 3
Modulating	2" - 8" WC	+/- 0.2" WC	75	100
Modulating	8.1" - 1.0 psig	+/- 3%	90	100
Modulating	1.1 - 15.0 psig	+/- 3%	95	100

**FIGURE 1
Pilot Valve Test Stand**

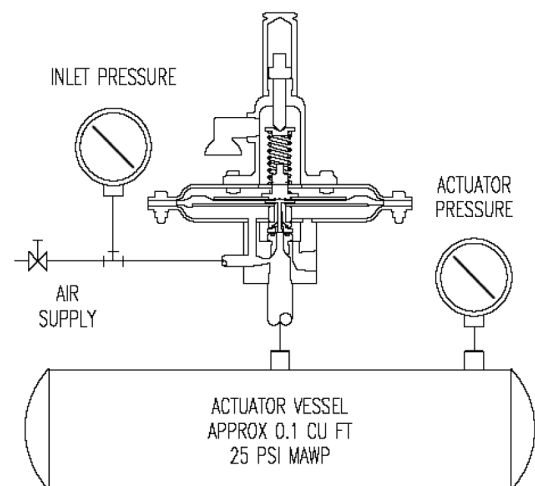
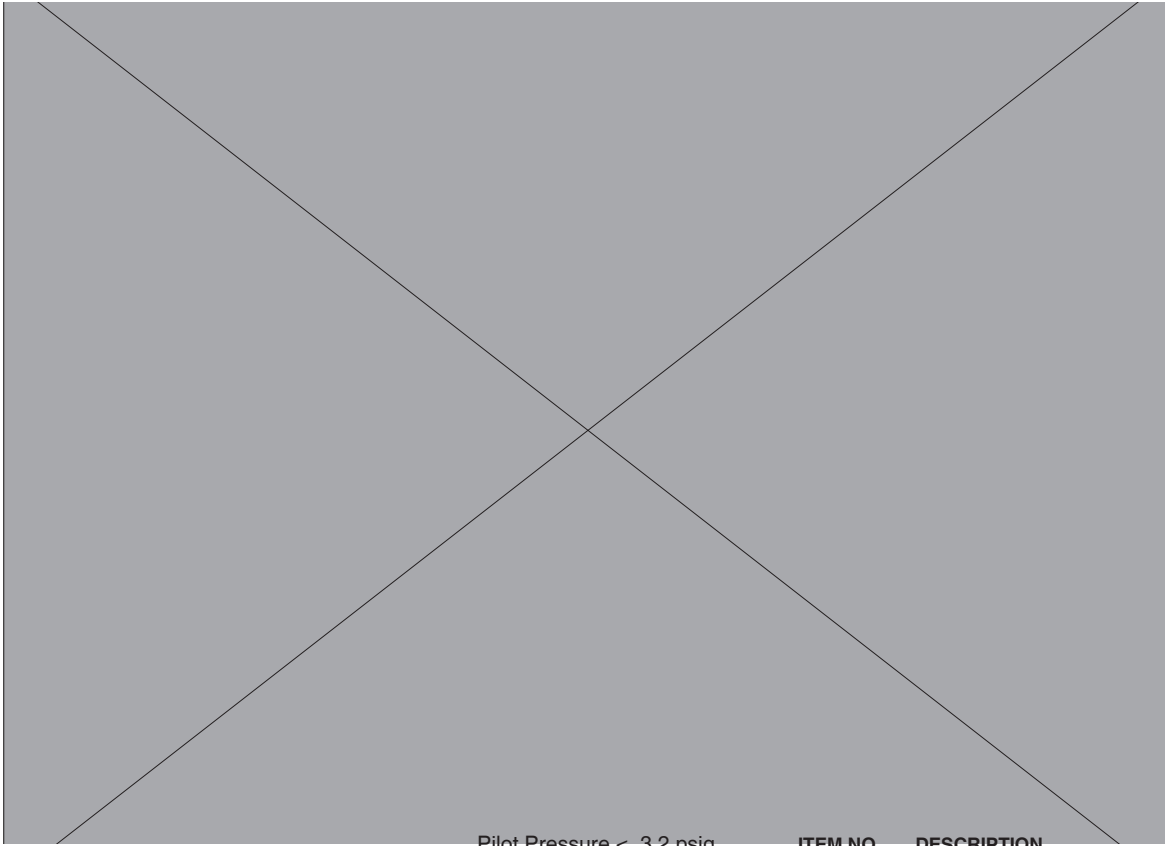

FIGURE 2 - PILOT VALVE



Pilot Pressure \leq 3.2 psig.

ITEM NO. DESCRIPTION

- 01 Pilot body
- 02 Body gasket *
- 03 Lower diaphragm case
- 04 Cap screw
- 05 Seat o-ring *
- 06 Spindle assy.
- 07 Bolt gasket *
- 08 Seal diaphragm *
- 09 Boost diaphragm spacer
- 10 Boost diaphragm *
- 11 Support plate - Boost
- 12 Sense diaphragm spacer
- 13 Diaphragm case spacer
- 14 Sense diaphragm *
- 15 Sense pressure ring
- 16 Support plate - Sense
- 17 Lower spring guide
- 18 Spindle stud
- 19 Nut
- 20 Range spring
- 21 Spring button
- 22 Upper diaphragm case
- 23 Spring bonnet
- 24 Exhaust screen
- 25 Washer - Diaphragm case
- 26 Cap screw - Diaphragm case
- 27 Jam nut - Adjusting screw
- 28 Adjusting screw / Blow down needle
- 29 Cap - Spring bonnet
- 30 O-ring - Blow down needle *
- 31 Exhaust fitting
- 32 Straight tube fitting
- 33 Compression elbow
- 34 Tubing
- 36 Boost Pressure Ring #

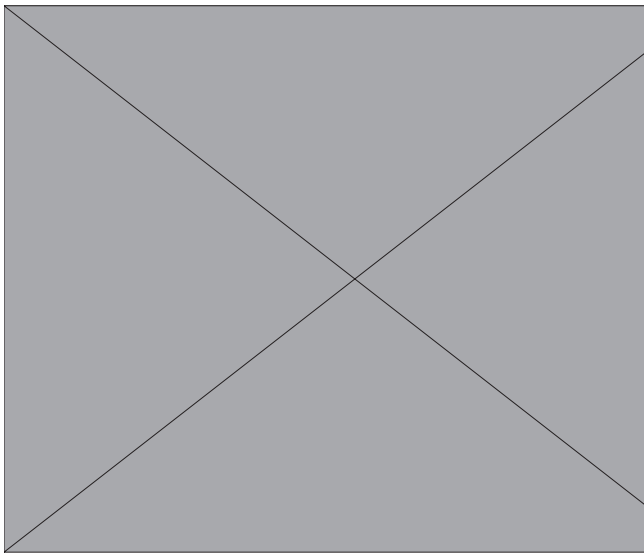

Pilot Pressure \geq 3.2 psig.

* Spare Parts # Intermediate & High Pressure Pilots ONLY

FIGURE 3 - MAIN VALVE

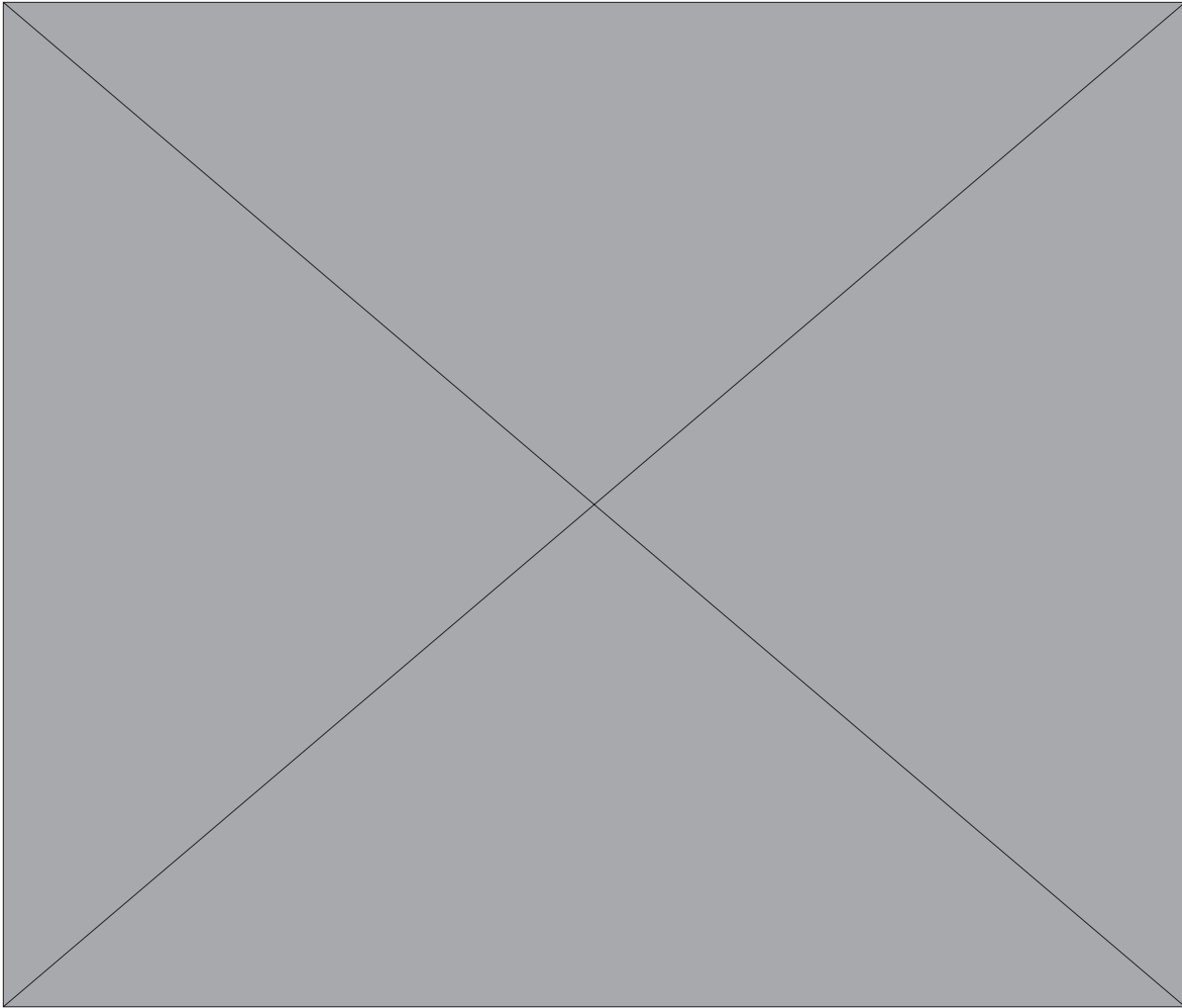

<u>ITEM NO.</u>	<u>DESCRIPTION</u>	<u>ITEM NO.</u>	<u>DESCRIPTION</u>
100	Spool piece	116	Upper Act. case assy.
101	Pipeaway body	117	Cap screw - Act. case
102	Seat ring	118	Nut - Act case
103	Seat ring bolts	119	Lifting bracket
104	Pallet stem	120	Cap screw - Lifting bracket
105	Stiffener plate	121	Pilot mounting nipple
106	Pallet	122	Sense tube connector 1
107	Diaphragm *	123	Sense tube connector 2
108	Diaphragm retainer	124	Sense tube
109	Lock nut - pallet	125	Discharge tube
110	Pallet guide	126	Plug
111	Cover	127	Support plate
112	Cap screw - Cover	128	Actuator diaphragm *
113	Gasket - Actuator case *	129	Name Plate
114	Lower Act. case assy.	130	Joint tape *
115	Cap screw		

* Spare parts

OPTION 1 - Remote Sense OPTION 2 - Manual Blow Down OPTION 3 - Backflow Preventer

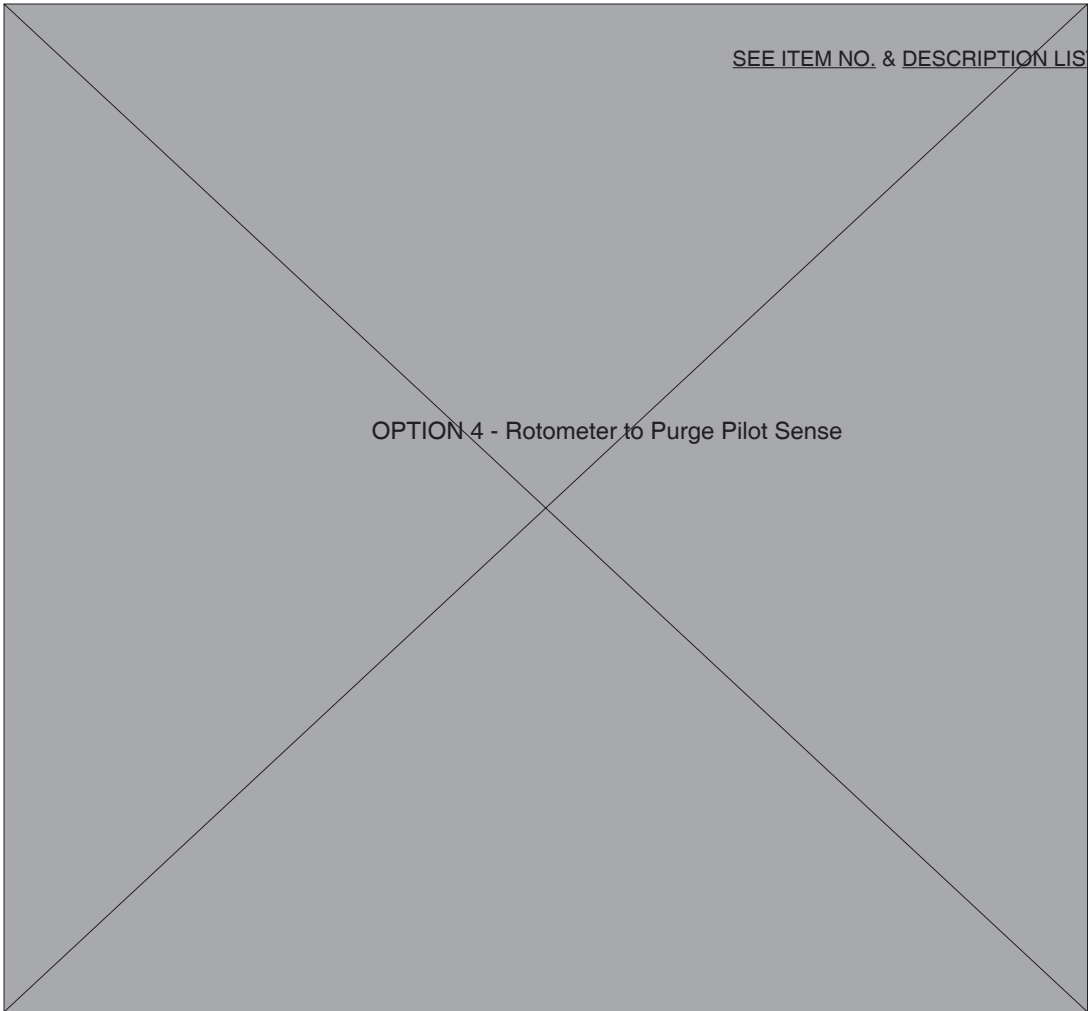
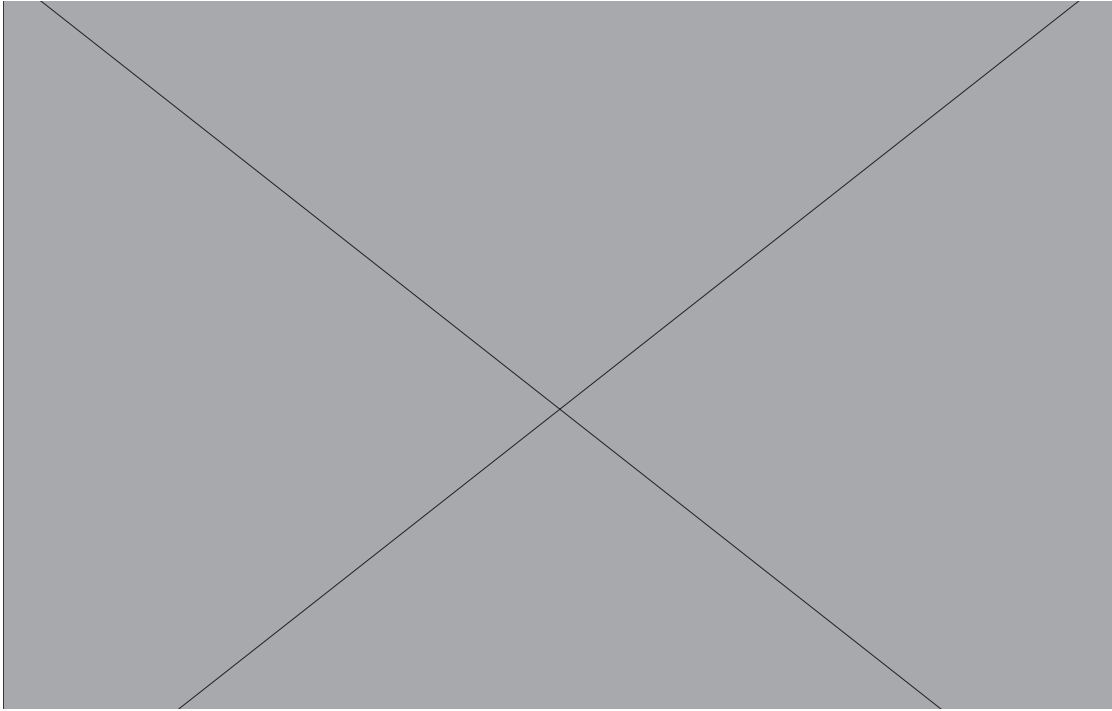

OPTION 5 - Rotometer to Purge Pilot Sense
and Discharge Line

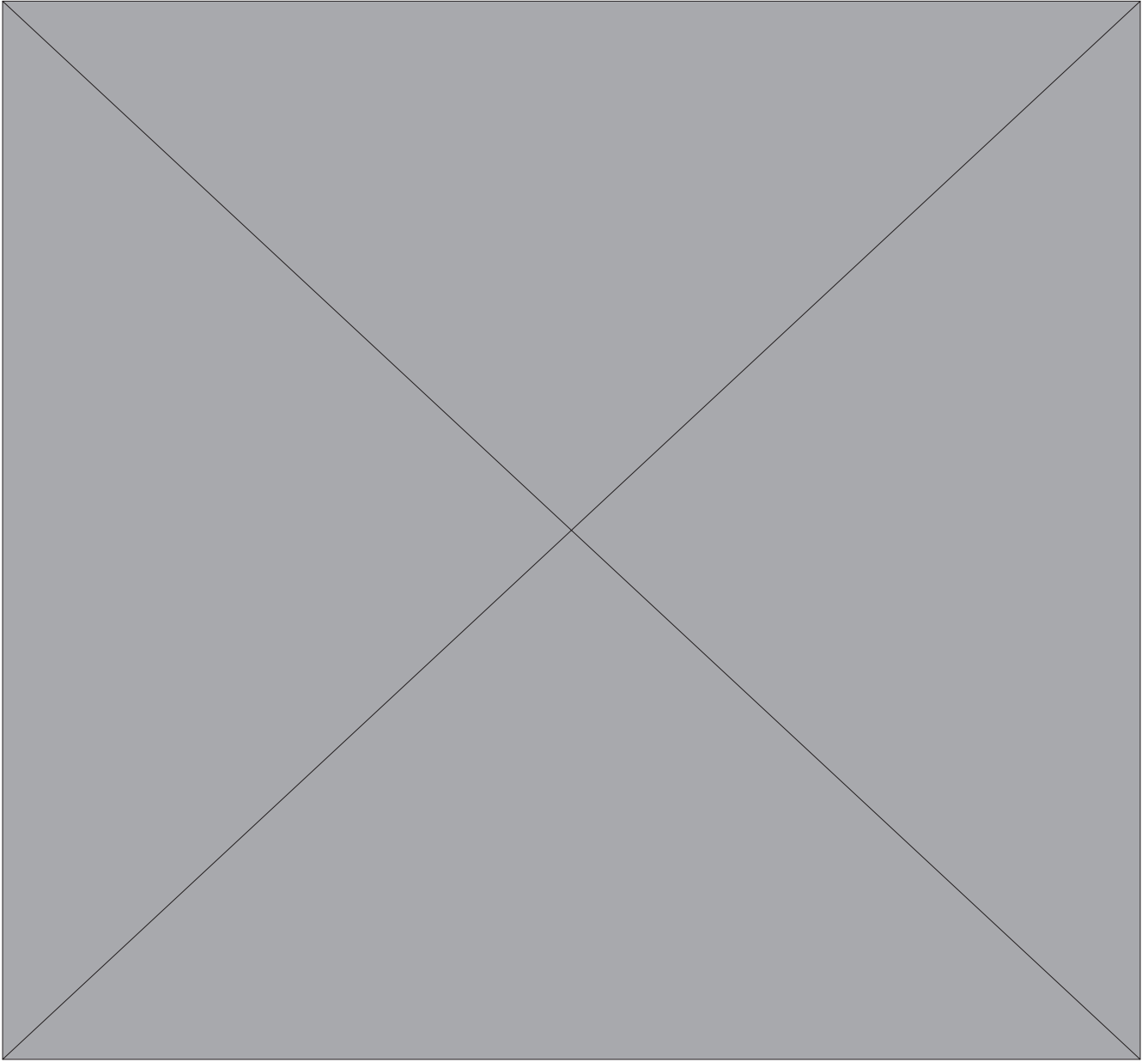

SEE ITEM NO. & DESCRIPTION LIST on page 15.

OPTION 6 - Air Assist

OPTION 7 - ATEX

SEE ITEM NO. & DESCRIPTION LIST on page 15.

OPTION 8 - Field Test Connection

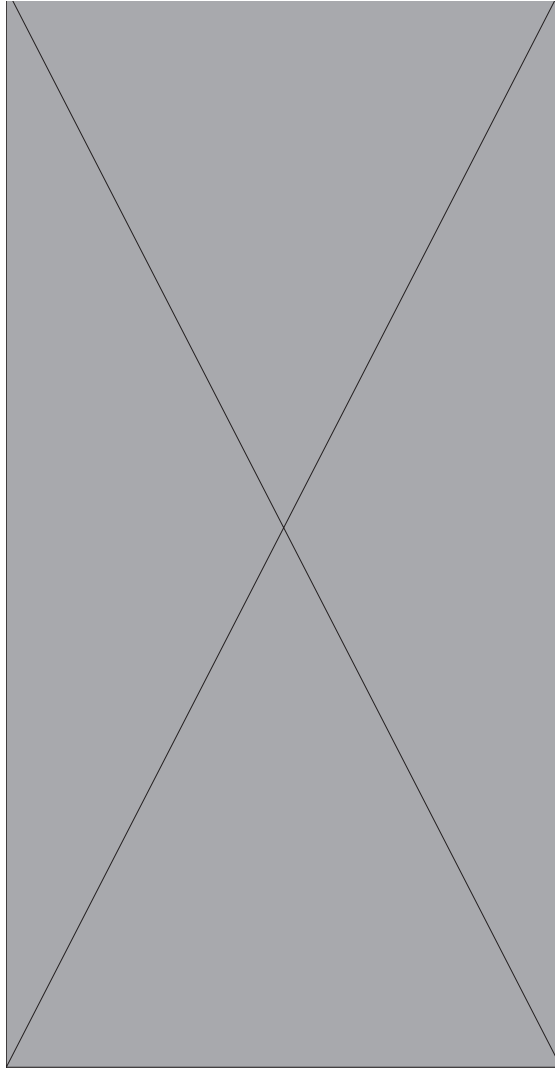

<u>ITEM NO.</u>	<u>DESCRIPTION - OPTION</u>	<u>ITEM NO.</u>	<u>DESCRIPTION - OPTION</u>
200	Plug - Remote sense	215	Red. bushing Gauge - Air assist
201	MNPT Tee - Manual blowdown	216	Pressure gauge - Air assist
202	Ball valve - Manual blowdown	217	MNPT Flow orifice - Purge
203	Nipple - Check valve	218	Purge meter - Purge
204	Check valve	219	Street Tee - Discharge purge
205	MNPT Tee - Field test conn.	220	Female Tee - Discharge purge
206	Push lock air fitting - Field test	221	Compression elbow - Discharge purge
207	Nipple - Purge	222	Straight tube fitting - Discharge purge
208	Street Tee - Purge	223	Tube - Discharge purge
209	Red. Bushing - Purge	224	Plug
210	Pipe plug - Air assist	300	Pallet guide - ATEX
211	Sense tube conn. - FNPT Air assist	301	Cable eyelet 1 - ATEX
212	Red. bushing - Air assist	302	Cable eyelet 2 - ATEX
213	Nipple - Air assist	303	Screw - ATEX
214	Filter Reg. - Air assist	304	Cable - ATEX

ADDENDUM - A

TIGHTENING SEQUENCE FOR FLANGE BOLTING

GUIDELINES FOR BOLTED FLANGE JOINT ASSEMBLY ACCORDING TO ASME PCC-1 SPECS

STEP	LOADING
Install	Hand tighten. Check flange gap around circumference for uniformity. If the gap is not reasonably uniform, make the appropriate adjustments by selective tightening before proceeding.
Round 1	Tighten to 20% to 30% of target torque. Check flange gap around circumference for uniformity. If the gap is not reasonably uniform, make the appropriate adjustments by selective tightening before proceeding.
Round 2	Tighten to 50% to 70% of target torque. Check flange gap around circumference for uniformity. If the gap is not reasonably uniform, make the appropriate adjustments by selective tightening before proceeding.
Round 3	Tighten to 100% of target torque. Check flange gap around circumference for uniformity. If the gap is not reasonably uniform, make the appropriate adjustments by selective tightening.

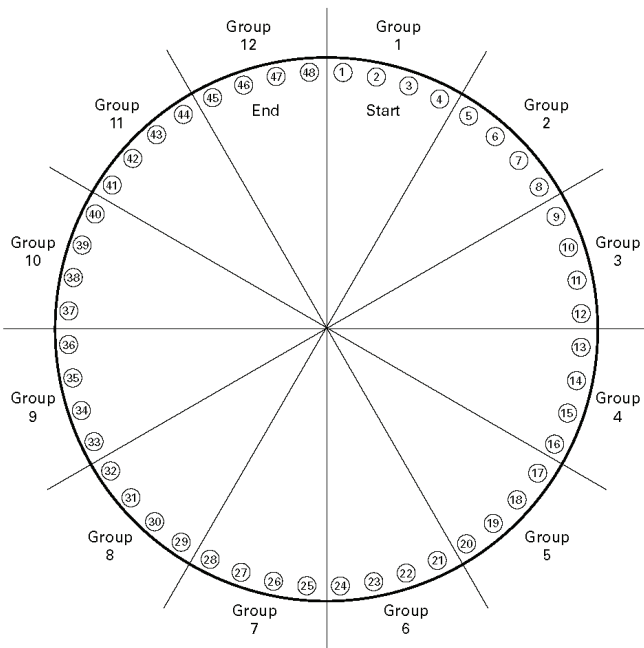

Group	Bolts
1	1-2-3-4
2	5-6-7-8
3	9-10-11-12
4	13-14-15-16
5	17-18-19-20
6	21-22-23-24
7	25-26-27-28
8	29-30-31-32
9	33-34-35-36
10	37-38-39-40
11	41-42-43-44
12	45-46-47-48

Tightening sequence for 12 Groups:

- 1-7-4-10 ↙
- 2-8-5-11 ↙
- 3-9-6-12

The 12-group sequence is the same as a 12-bolt sequence

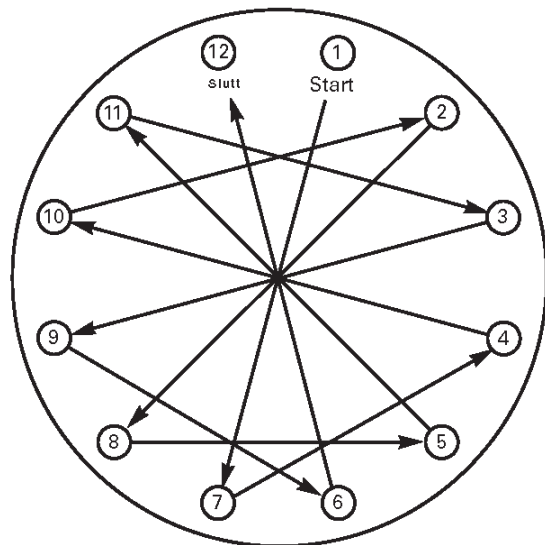

1-7-4-10 → 2-8-5-11 → 3-9-6-12

RECOMMENDATIONS FOR PROPER GASKET INSTALLATION

Gasket seating surfaces for tank nozzle flange must be clean, free of scratches, corrosion, tool marks and flat. Use either a full faced or ring gasket for steel and stainless steel raised face flanges

FRP and Aluminum vents are furnished with flat faced flanges. It is recommended that they be installed on mating flat face flanges with a full faced gasket. If the flat face of the vent is sealing against a raised face steel flange, a spacer or filler ring must be used to fill the annular space of the raised face steel flange.

Refer to Gasket Dimension Table.

Ensure that the gasket material is suitable for the service. Make sure that the gasket is compressed evenly and the flanges are not distorted. Utilizing proper torquing techniques will ensure a tight seal and prevent leakage around the gasket. See preceding page.

NOTE: *Incorrect positioning and/or selection of gasket(s) between the flanges will cause bending stresses at the flange that may damage the flange joint as bolting is tightened. This is more likely to occur with aluminum or cast iron materials.*

Correct Installation

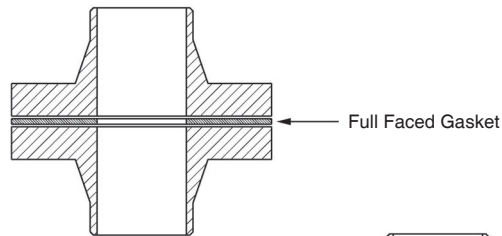

Incorrect Installation

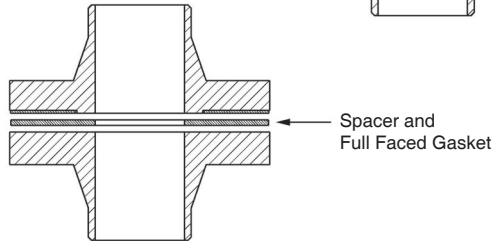
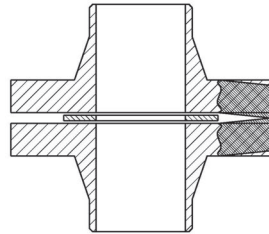

Correct Installation

ATEX 94/9/EC: Explosive Atmospheres and Cashco Inc. Regulators



These valves satisfy the safety conditions according to EN 13463-1 and EN 13463-5 for equipment group IIG 2 c.

Caution: Because the actual maximum temperature depends not on the equipment itself, but upon the fluid temperature, a single temperature class or temperature cannot be marked by the manufacturer.

Specific Precaution to Installer: Electrical grounding of valve must occur to minimize risk of effective electrical discharges.

Specific Precaution to Installer: Atmosphere vent holes should be plugged to further minimize the risk of explosion.

Specific Precaution to Maintenance: The Valve Body/ Housing must be regularly cleaned to prevent buildup of dust deposits.

Specific Precaution to Maintenance: Conduct periodic Continuity Check between Valve Body/ Housing and Tank to minimize risk of electrical discharges.

Attention: When repairing or altering explosion-protected equipment, national regulations must be adhered to. For maintenance and repairs involving parts, use only manufacturer's original parts.

ATEX requires that all components and equipment be evaluated. Cashco pressure regulators are considered components. Based on the ATEX Directive, Cashco considers the location where the pressure regulators are installed to be classified Equipment-group II, Category 3 because flammable gases would only be present for a short period of time in the event of a leak. It is possible that the location could be classified Equipment-group II, Category 2 if a leak is likely to occur. Please note that the system owner, not Cashco, is responsible for determining the classification of a particular installation.

Product Assessment

Cashco performed a conformity assessment and risk analysis of its pressure regulator and control valve models and their common options, with respect to the Essential Health and Safety Requirements in Annex II of the ATEX directive. The details of the assessment in terms of the individual Essential Health and Safety Requirements, are listed in Table 1. Table 2 lists all of the models and options that were evaluated and along with their evaluation.

Models and options not listed in Table 2 should be assumed to not have been evaluated and therefore should not be selected for use in a potentially explosive environment until they have been evaluated.

Standard default options for each listed model were evaluated even if they were not explicitly listed as a separate option in the table. Not all options listed in the tables are available to all models listed in the tables. Individual TB's must be referenced for actual options.

When specifying a regulator that is to be used in a potentially explosive environment one must review the evaluations in Table 1 and 2 for the specific model and each and every option that is being specified, in order to determine the complete assessment for the unit.

A summary of the models and options found to have an impact on ATEX assessment due to potential ignition sources or other concerns from the ATEX Essential Health and Safety Requirements, are listed below.

1. The plastic knob used as standard on some models, (P1, P2, P3, P4, P5, P7, 3381, 4381, 1171, and 2171) is a potential ignition source due to static electricity. To demonstrate otherwise, the knob must be tested to determine if a transferred charge is below the acceptable values in IEC 60079-0 Section 26.14 (See items 25, 27, and 28 in Appendix A). Until the plastic knob has been shown to be acceptable, then either the metal knob option, or a preset outlet pressure option is required to eliminate this ignition source (See items 45 and 64 in Tables).
2. The pressure gauges offered as options on a few of the regulator models (DA's, P1-7, D, 764, 521), use a plastic polycarbonate window that is a potential ignition source due to static electricity. To demonstrate that the gauges are not a potential source of ignition, the gauges would need to be tested to determine if a transferred charge is below the acceptable values in IEC 60079-0 Section 26.14 or the pressure gauge supplier must provide documentation

indicating the gauge is compliant with the ATEX Directive (See items 26, 27, and 28 in Appendix A). Until compliance is determined, regulators should not be ordered with pressure gauges for use in potentially explosive environments.

3. Tied diaphragm regulators with outlet ranges greater than 100 psig should be preset to minimize the risk that improper operation might lead to an outboard leak and a potentially explosive atmosphere (See item 6 in Table 1).
4. Regulators must be ordered with the non-relieving option (instead of the self-relieving option) if the process gas they are to be used with is hazardous (flammable, toxic, etc.). The self-relieving option vents process gas through the regulator cap directly into the atmosphere while the non-relieving option does not. Using regulator with the self-relieving option in a flammable gas system could create an explosive atmosphere in the vicinity of the regulator.
5. Regulators with customer supplied parts are to be assumed to not have been evaluated with regard to ATEX and thus are not to be used in a potentially explosive environment unless a documented evaluation for the specific customer supplied parts in question has been made. Refer to Table 1 for all models and options that have been evaluated.

Product Usage

A summary of ATEX related usage issues that were found in the assessment are listed below.

1. Pressure regulators and control valves must be grounded (earthed) to prevent static charge build-up due to the flowing media. The regulator can be grounded through any mounting holes on the body with metal to metal contact or the system piping can be grounded and electrical continuity verified through the body metal seal connections. Grounding of the regulator should follow the same requirements for the piping system. Also see item 30 in Table 1.
2. The system designer and users must take precautions to prevent rapid system pressurization which may raise surface temperatures of system components and tubing due to adiabatic compression of the system gas.
3. Heating systems installed by the user could possibly increase the surface temperature and must be evaluated by the user for compliance with the ATEX Directive. User installation of heating systems applied to the regulator body or system piping that affects the surface temperature of the pressure regulator is outside the scope of this declaration and is the responsibility of the user.
4. The Joule-Thomson effect may cause process gases to rise in temperature as they expand going through a regulator. This could raise the external surface temperature of the regulator body and downstream piping creating a potential source of ignition. Whether the Joule-Thomson effect leads to heating or cooling of the process gas depends on the process gas and the inlet and outlet pressures. The system designer is responsible for determining whether the process gas temperature may rise under any operating conditions. If a process gas temperature rise is possible under operating conditions, then the system designer must investigate whether the regulator body and downstream piping may increase in temperature enough to create a potential source of ignition.

The process gas expansion is typically modeled as a constant enthalpy throttling process for determining the temperature change. A Mollier diagram (Pressure – Enthalpy diagram with constant temperature, density, & entropy contours) or a Temperature – Entropy diagram with constant enthalpy lines, for the process gas, can be used to determine the temperature change. Helium and hydrogen are two gases that typically increase in temperature when expanding across a regulator. Other gases may increase in temperature at sufficiently high pressures.

Product Declaration

If the above issues are addressed by selecting options that do not have potential sources of ignition, avoiding options that have not been assessed, and by taking the proper usage issue precautions, then Cashco regulators can be considered to be a mechanical device that does not have its own source of ignition and thus falls outside the scope of the ATEX directive.

Cashco, Inc.
P.O. Box 6
Ellsworth, KS 67439-0006
PH (785) 472-4461
Fax. # (785) 472-3539
www.cashco.com
email: sales@cashco.com
Printed in U.S.A. 5500-IOM

Cashco GmbH
Handwerkerstrasse 15
15366 Hoppegarten, Germany
PH +49 3342 30968 0
Fax. No. +49 3342 30968 29
www.cashco.com
email: germany@cashco.com

Cashco do Brasil, Ltda.
Al.Venus, 340
Indaiatuba - Sao Paulo, Brazil
PH +55 11 99677 7177
Fax. No.
www.cashco.com
email: brazil@cashco.com